

Single CCT Apollo Flex Strip Data Sheet

30W/m 6000K CRI90 48V IP20

*Features

- 6000K, high CRI 90
- High power 30W/m, high brightness 3150lm/m for general lighting
- High efficiency 105lm/W
- Comfortable and uniform light with no lighting dot by 3D SMD LED
- 48V, high power efficiency
- Wide beam angle 180°
- Easy to cut
- 3M adhesive back tape
- Good dissipation, 25000hrs lifespan, 40000hrs long lifespan with heatsink

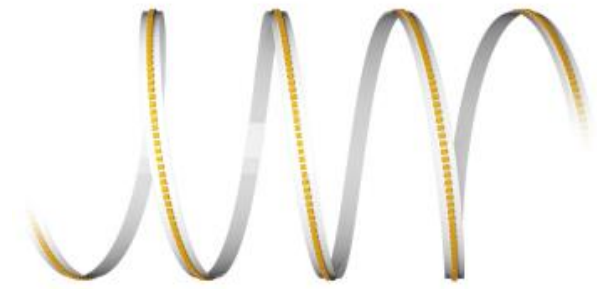

Technical data

Electrical specifications			
Part No.	CTS6C130G105-76516	EAN	4060574765169
Wattage (W/m)	30	AC input voltage (V)	-
DC output voltage (V)	48	Power factor	-
Frequency (Hz)	-	Total harmonic distortion (THD)	-
Dimmable	Yes	Flicker-free	-
Max. no. of lamps on B16A circuit breaker	-	Max. no. of lamps on C10A circuit breaker	-
Max. no. of lamps on C16A circuit breaker	-		
Photometric specifications			
Colour temperature (CCT)	6000K	CRI (Ra)	90
Luminous efficiency (lm/W)	105	Luminous flux (lm/m)	3150
Standard deviation of colour	3 SDCM	Beam angle (°)	180
UGR	-		
Mechanical specifications			
Housing material	FPC	Housing Colour	White
Optical cover/ lens material	-	Length/ diameter (mm)	5000
Width/ diameter (mm)	10	Height (mm)	1.45
Cut length (mm)	45	Product weight	60g
Lifespan			
Number of switching cycles	100000	L70/B50 service life at 25°C	40,000 hrs
L80/B10 service life at 25°C	25,000 hrs	L90/B10 service life at 25°C	20,000 hrs
Warranty period	5 Years		
Application parameters			
Working temperature range	-20~+60°C	Storage temperature range	-20~+70°C

Additional product specifications

Type of installation	3M adhesive tape
Connection type	Connector

Additional product specifications

Location of installation	-
Protection type	IP20

- Power off before replacement
- Do not be in violation of any fire regulations when using
- Consult qualified electricians for technical support
- If the supply cord is damaged, it shall be exclusively replaced by the manufacturer or his service agent or similar qualified person in order to avoid a hazard

Dimensions

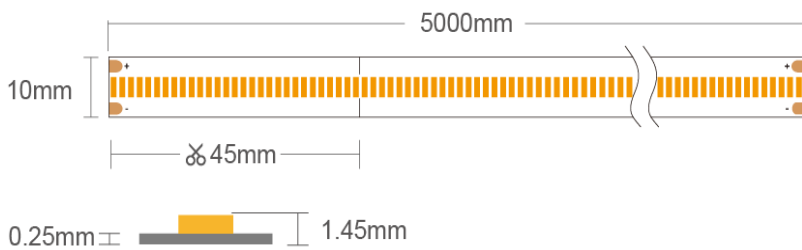

***Product & Wiring Connection & Cautions**

Product connections

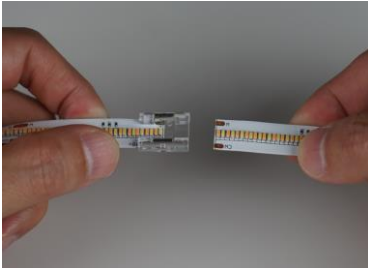

Insert each ends of led strips into the end of the connection terminal respectively, make sure the metal clip is on the same side as the metal solder pad of led strip.

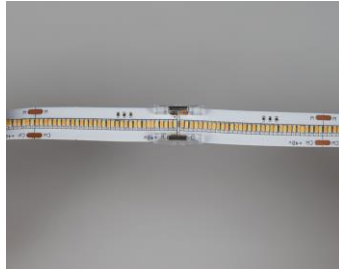

After complete the insert, also make sure both ends of led strip are tightly connected.



Press the metal clip down with the appropriate plier to ensure that the metal clip is inserted into the appropriate position ,and connection completed.

Wiring connections

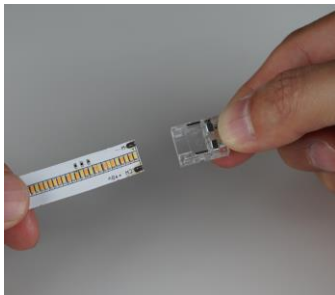

Insert one end of led strip and wire connector into both ends of the connection terminal respectively to ensure that the metal clip is on the same side as the metal solder pad of led strip.



Meanwhile make sure both ends are closely connected, Press the metal clip down with the appropriate plier to ensure that the metal clip is inserted into the appropriate position ,and connection completed.

Cautions

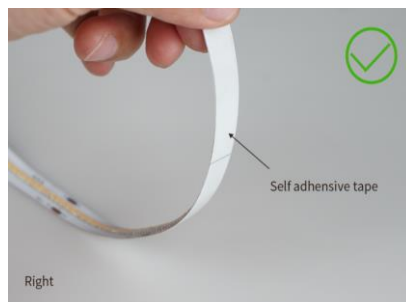
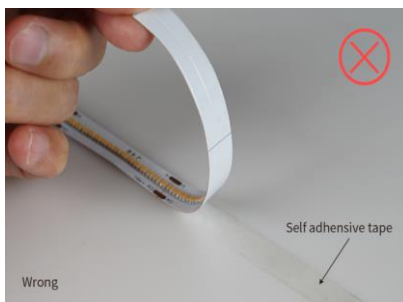

If the led strip needs to be torn up,please make sure that the self adhesive tape is torn with the led strip,otherwise the led strip will be damaged.

When install the led strip,please note the installation technique
The led strip can be bent, but not distorted,as shown below

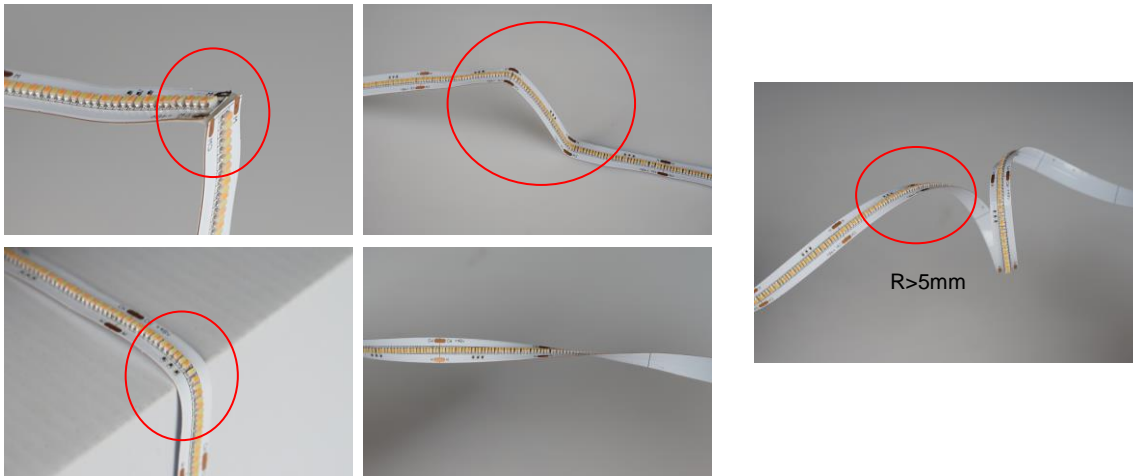

Distortion (Wrong)

Bend (Right)

➤ LED strips are low voltage products, you must use the power supply(transformer). Please don't connect the led strip directly to the AC 110v or AC 220v, otherwise it will burn out the LED strips.

➤ Clean up the installation surface and it will ensure the reliability of the adhesive. The electrical connection process must be operated by a professional person.

Wiring Diagram



***Installation Step**

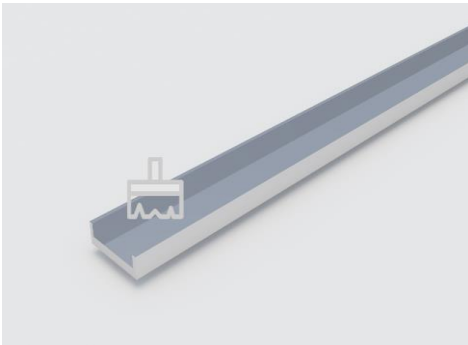

1. Clean



2. Peel off the adhesive tape and stick the strip

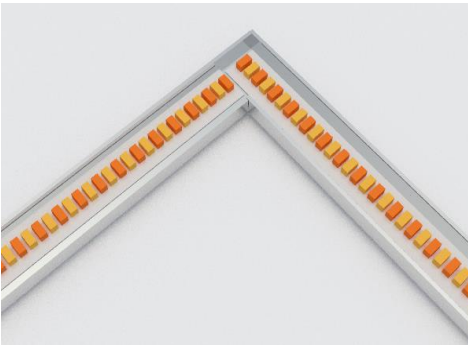

3. Vertical installation

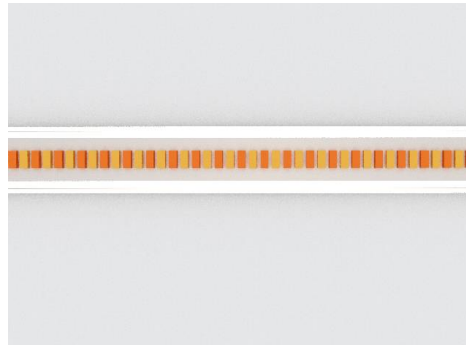

4. Done

***Accessories / Parts (Optional):**



*Semi-transparent Plastic Cover



*Connector Clamp



*Aluminum slot Clamp



*Aluminum slot

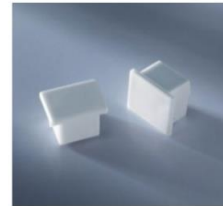

*Square plastic Cover